

Hook fixing

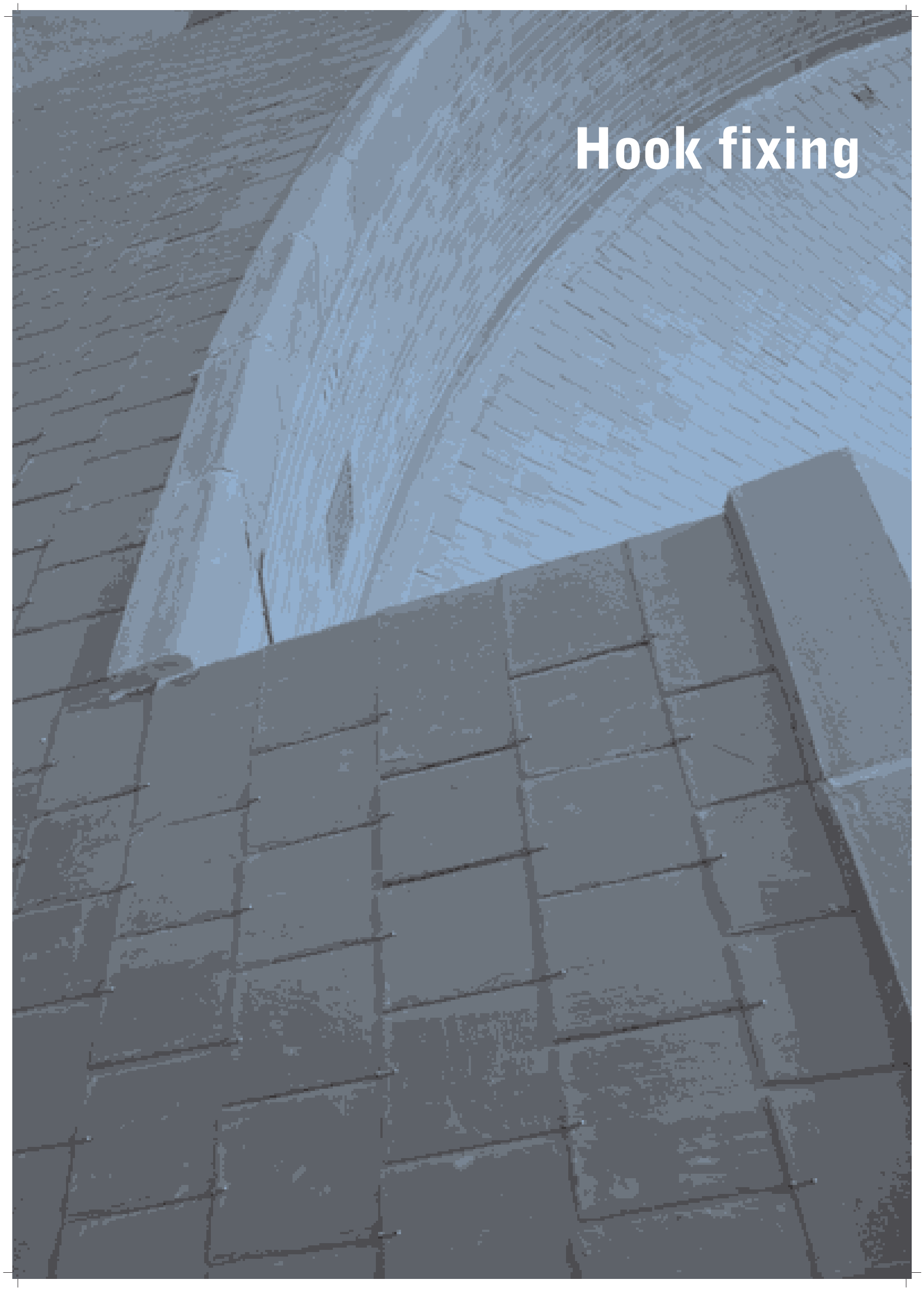

Design work

Design considerations

Effective design of a slate roof must take into account a number of inter-related factors including site exposure, the pitch of the roof, the type of slate selected and the slate lap.

General guidance on the most important points to be considered is given below. Full application and sitework details are given on pages 28 to 42. Further information can be obtained from BS 5534: 1997, Code of practice for slating and tiling, Part 1: Design.

Reference should be made also to BS 8000: 1990 (1997), Workmanship on building sites, Part 6: Code of practice for slating and tiling of roofs and claddings.

Environmental conditions

a Rain exposure

The degree of exposure of a building to driving rain determines the minimum lap which should be specified.

The anticipated degree of exposure is given in Figure 3 (taken from BS 5534: Part 1: 2014).

Localised factors such as high buildings, buildings on the slopes or tops of hills and coastal sites, can increase the exposure grading which should be applied in a specific project. Table 1 on page 5 shows the recommended minimum lap for moderate and severe exposure sites.

For more detailed information on exposure to rain refer to BS 8104: 1992.

b Wind uplift

Adequate resistance to wind load and wind lift provided by following the application details shown on pages 28 to 41, taking into account minimum lap recommendations given in Table 1.

Design calculations for wind load and wind uplift are given in BS 5534: Part 1, BRE Digest 346: Parts 1 to 7 and BS 6399: Part 2: 1990, Code of practice for wind loads, which replaces BS CP3: Chapter 5: Part 2: 1972.

Pitch of roof

In general, the lower the pitch of the roof, the greater should be the lap. This longer lap will help to resist both capillary action and wind uplift.

On steeper pitches with free-flowing drainage, smaller slates may be used.

For exposed sites, wide slates with a greater lap should be used (see Clause 18 of BS 5534).

In sheltered areas, roof pitches as low as 14° can be achieved using the SSQ hook fixing system.

Lap

The lap is calculated by taking account of wind uplift, exposure to driving rain and the roof pitch. Table 3 gives the recommended minimum laps for various roof pitches and building exposures.

Figure 1 Categories of exposure to driving rain



Exposure Zones	Approximate wind driven rain (litres/m ² per spell)
	Less than 56.6 (Moderate exposure)
	equal to or greater than 56.5 (Severe exposure)



Table 3 Minimum head lap for fixing slates with nails or hooks according to BS 5534: 2003**Moderate exposure (less than 56.5 l/m)**

Slate size (mm) length · width	Rafter pitch								
	20°	22.5°	25°	27.5°	30°	35°	40°	45°	80°
600 · 300	115	105	95	85	80	70	60	55	
500 · 300	115	105	95	85	80	70	60	55	
500 · 250		105	95	85	80	70	60	55	50
450 · 300					80	70	60	55	50
450 · 220					80	70	60	55	50
400 · 300					80	70	60	55	50
400 · 250					80	70	60	55	50
400 · 200					80	70	60	55	50
350 · 250					80	70	60	55	50
350 · 200					80	70	60	55	50
320 · 220					80	70	60	55	50
300 · 200					80	70	60	55	50
270 · 180					80	70	60	55	50
250 · 150						70	60	55	50

Severe exposure (56.5 l/m or over)

Slate size (mm) length · width	Rafter pitch								
	20°	22.5°	25°	27.5°	30°	35°	40°	45°	80°
600 · 300	145	130	120	110	100	90	80	70	
500 · 300		130	120	110	100	90	80	70	
500 · 250		130	120	110	100	90	80	70	65
450 · 300					100	90	80	70	65
450 · 220					100	90	80	70	65
400 · 300					100	90	80	70	65
400 · 250					100	90	80	70	65
400 · 200					100	90	80	70	65
350 · 250					100	90	80	70	65
350 · 200					100	90	80	70	65
320 · 220					100	90	80	70	65
300 · 200					100	90	80	70	65
270 · 180						90	80	70	65
250 · 150								70	65

Battens

Recommended timber batten sizes for natural slate roofs are 50 · 25 mm, up to 600 mm rafter spans, according to BS 5534: Part 1: 1997.

Battens should be set out horizontally across the roof at a gauge calculated from the formula:

$$\text{gauge} = \frac{(\text{length of slate} + 10 \text{ mm}) - \text{hook length}}{2}$$

Battens should be nailed at maximum 600 mm centres, with the end of each length fully supported and be not less than 50 mm wide by 25 mm thick.

Note If used, counterbattens should be a minimum 38 – 25 mm.

Underlay

Underlay should be selected to meet the requirements of Clause 13 of BS 5534: Part 1: 1997. Where the underlay is not fully supported, it should be Type 1F reinforced bitumen felt to BS 747: 1977 (1986) or other approved material of adequate strength and durability.

Ventilation

To comply with the Building Regulations F2: 1995 and BS 5250: 1989 (1995), Code of practice for control of condensation in buildings, ventilation equivalent to a 10 mm continuous vent must be provided at the eaves on both sides of the roof when the roof is of a cold roof construction.

Additional ventilation must be provided by vent ridge tiles if the roof is of a warm roof construction.

Fixing methods

All SSQ natural slates can be fixed by using either traditional holing and nailing (see pages 10 to 24) or the hook fixing system (see pages 30 to 44). The hook method offers considerable freedom in design and can save up to 25% on labour costs and eliminate waste from slate breakage.

With the hook fixing system, the slates are secured at the tail, thus providing stronger resistance to wind uplift.

Hooks

Hooks should be black stainless steel, conforming to BS EN 10088 - 3 : 2005 grade 316, 2.7 mm gauge and at least 10 mm longer than the minimum lap required. Where battens coincide with rafters, nail hook must be used.

Coverage of slates

See Table 4 for coverage of all slate sizes at different laps.

Weight of slate roof

The total weight of slates on a roof can be calculated as follows:

Example

Slate type	Del Carmen
Slate size (mm · mm)	400 · 250
Weight of slates (kg/1000)	1235
Exposure	Moderate
Roof pitch	40°
Roof area m ²	150
Length of roof slope (m)	9.5

The **headlap** can be found from Table 3 by reference to length of roof slope, roof pitch and exposure = **100 mm**.

The slate **coverage** per m² can be found from Table 4 = **26.7**.

The **total weight** of slates on roof can be found from the formula:

$$\frac{\text{weight of slates (kg)} \cdot \text{area of roof (m}^2\text{)} \cdot \text{slate coverage}}{1000}$$

$$\begin{aligned} \text{Therefore, the total weight} &= \\ &= 1235/1000 \cdot 150 \cdot 26.7 \\ &= \mathbf{4946 \text{ kg}} \end{aligned}$$

Figure 2 Cold and warm roof ventilation

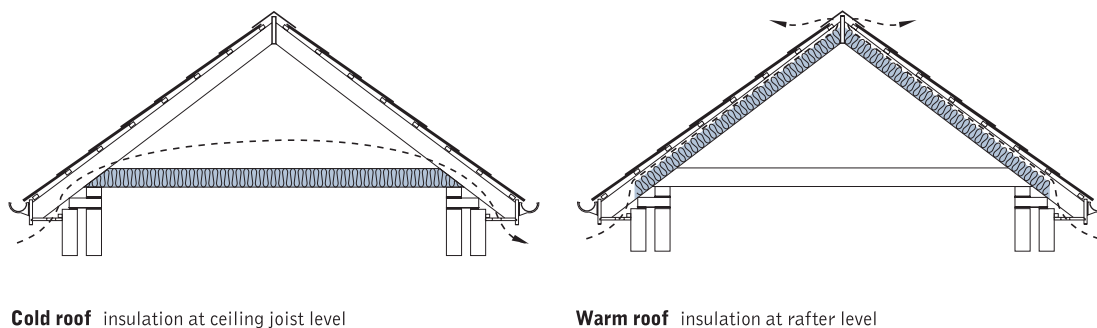

Cold roof insulation at ceiling joist level

Warm roof insulation at rafter level

Table 4 Coverage of SSQ slates with hook fixing method

Slate size (mm) length · width	Lap (mm)											
	50	65	75	80	85	90	95	100	105	110	115	120
	Number of slates/m ²											
600 · 300	12.1	12.5	12.7	12.8	12.9	13.1	13.2	13.3	13.5	13.6	13.7	13.9
550 · 300	13.3	13.7	14.0	14.2	14.3	14.5	14.7	14.8	15.0	15.2	15.3	15.5
550 · 280	14.3	14.7	15.0	15.2	15.4	15.5	15.7	15.9	16.1	16.2	16.4	16.6
500 · 300	14.8	15.3	15.7	15.9	16.1	16.3	16.5	16.7	16.9	17.1	17.3	17.5
500 · 250	17.8	18.4	18.8	19.0	19.3	19.5	19.8	20.0	20.3	20.5	20.8	21.0
450 · 300	16.7	17.3	17.8	18.0	18.3	18.5	18.8	19.0	19.3	19.6	19.9	20.2
450 · 250	20.0	20.8	21.3	21.6	21.9	22.2	22.5	22.9	23.2	23.5	23.9	24.2
450 · 230	21.7	22.6	23.2	23.5	23.8	24.2	24.5	24.8	25.2	25.6	26.0	26.3
400 · 300	19.0	19.9	20.5	20.8	21.2	21.5	21.9	22.2	22.6	23.0	23.4	23.8
400 · 250	22.9	23.9	24.6	25.0	25.4	25.8	26.2	26.7	27.1	27.6	28.1	28.6
400 · 200	28.6	29.9	30.8	31.3	31.7	32.3	32.8	33.3	33.9	34.5	35.1	35.7
350 · 300	22.2	23.4	24.2	24.7	25.2	25.6	26.1	26.7	27.2	27.8		
350 · 250	26.7	28.1	29.1	29.6	30.2	30.8	31.4	32.0	32.7	33.3		
350 · 200	33.3	35.1	36.4	37.0	37.7	38.5	39.2	40.0	40.8	41.7		
320 · 220	33.7	35.7	37.1	37.9	38.7	39.5	40.4	41.3	42.1	43.3		
320 · 180	41.2	43.6	45.4	46.3	47.3	48.3	49.4	50.5	51.7	53.0		
300 · 200	40.0	42.6	44.4	45.5	46.5	47.6	48.8	50.0				
300 · 150	53.3	56.7	59.3	60.6	62.0	63.5	65.0	66.7				

Slate size (mm) length · width	Lap (mm)					
	125	130	135	140	145	150
	Number of slates/m ²					
600 · 300	14.0	14.2	14.3	14.5	14.6	14.8
550 · 300	15.7	15.9	16.1	16.3	16.5	16.5
550 · 280	16.8	17.0	17.2	17.4	17.6	17.9
500 · 300	17.8	18.0	18.3	18.5	18.8	19.0
500 · 250	21.3	21.6	21.9	22.2	22.5	
450 · 300	20.5	20.8	21.2	21.5	21.9	
450 · 250	24.6	25.0	25.4	25.8	26.2	
450 · 230	26.8	27.2	27.6	28.1	28.5	
400 · 300	24.2					
400 · 250	29.1					
400 · 200	36.4					

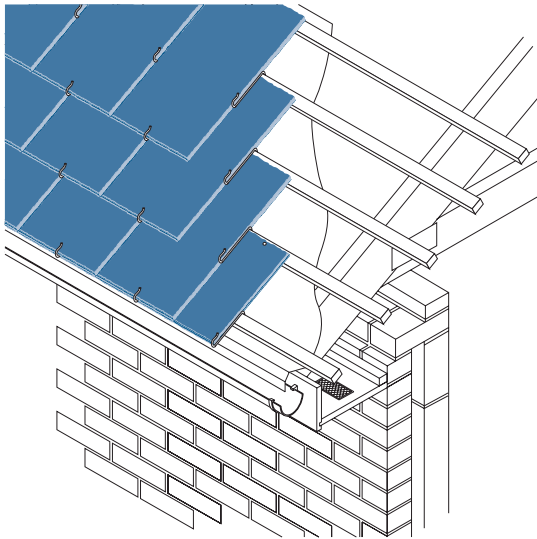

Eaves

At all eaves, a double course of slates is required, comprising a course of short slates over which the first course of full length slates is fixed.

The length of the eaves slates should be gauge + lap.

Fixing sequence at eaves

- 1 Fix the underlay to extend over the tilting fillet and fascia board into the gutter. The underlay should overhang the fascia board by 50 mm.
- 2 Fix the first full course batten (the eaves batten) so that the tails of the slates in the eaves and the undereaves courses align, ensuring that they will overhang 50 to 60 mm into the gutter. Fix an undereaves batten below the eaves batten at a position which corresponds with the hook length from the tail of the eaves course slates (see page 26 for minimum batten dimensions).
- 3 Lay the slates forming the undercourse on their backs and head nail them to the eaves batten.
- 4 Fix the eaves course with the tails of the slates aligning with the tails of slates in the undereaves course.
- 5 Commence hook fixing on second course of slates.

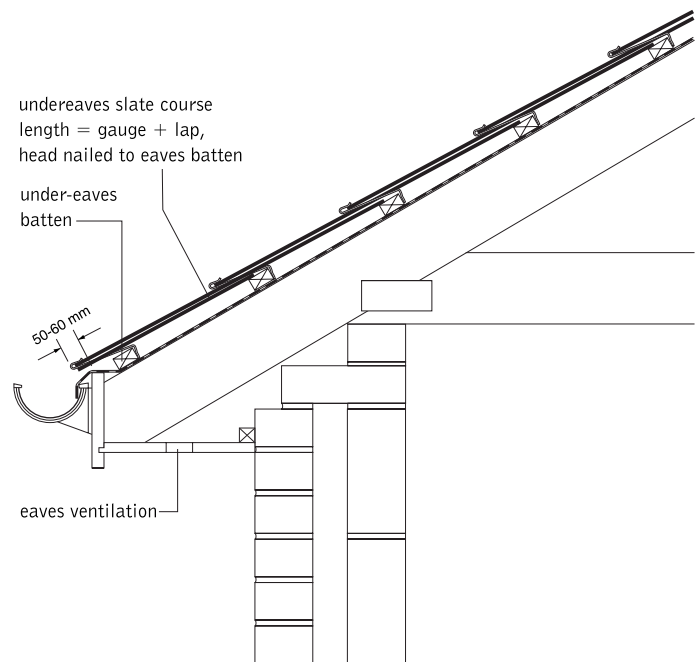

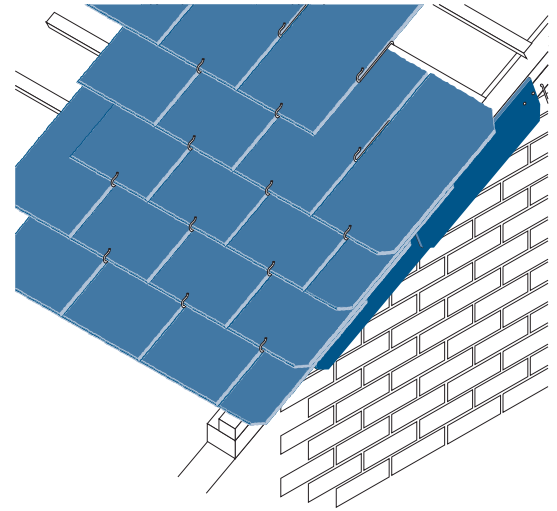
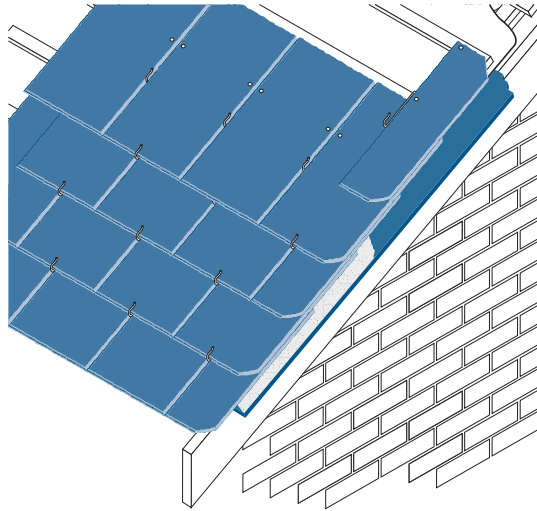

Verges

Where an undercloak is fixed it should consist of one or more courses of slates not less than 4.5 mm thick, laid riven side up and closely butted.

If more than one course is used, joints should be staggered.

Fixing sequence at verge on bargeboard

The verge should be finished with full slates and half slates in alternate courses. The full slate should be fixed with one nail in addition to the hook; the half slate should be fixed with two nails. Provision may be made for a slight inward tilt from the verge.

Mortar for bedding and pointing; 1:3 cement/sand pigmented to match colour of slates.

- 1 Fix the undercloak with nails so that it overhangs the face of the bargeboard by 40 to 50 mm.
- 2 Fill the gap between the undercloak and slates with mortar and strike off smoothly to provide a flush joint.

Fixing sequence at verge on brickwork

- 1 Fix one batten parallel to the verge.
- 2 The verge should be finished with full slates and half slates in alternate courses. The full slate should be fixed with one nail in addition to the hook; the half slate should be fixed with two nails. Provision may be made for a slight inward tilt from the verge.
- 3 Clad timber with slates fixed with two nails and one hook. Slates must overhang the timber by at least 50 mm and overlap one another by 75 mm.

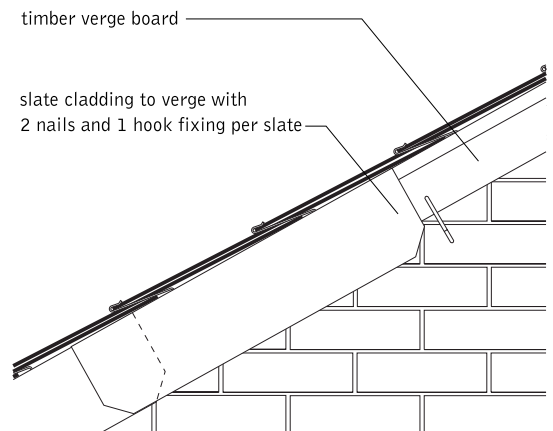
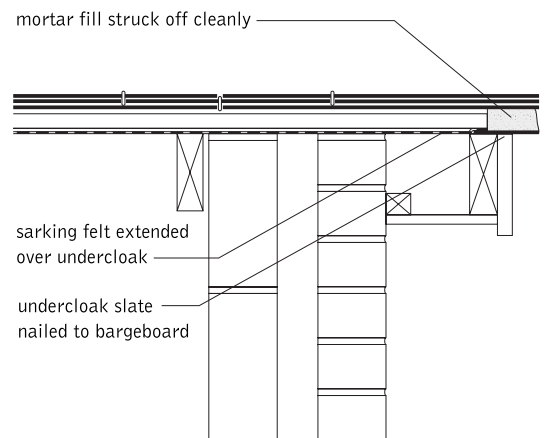

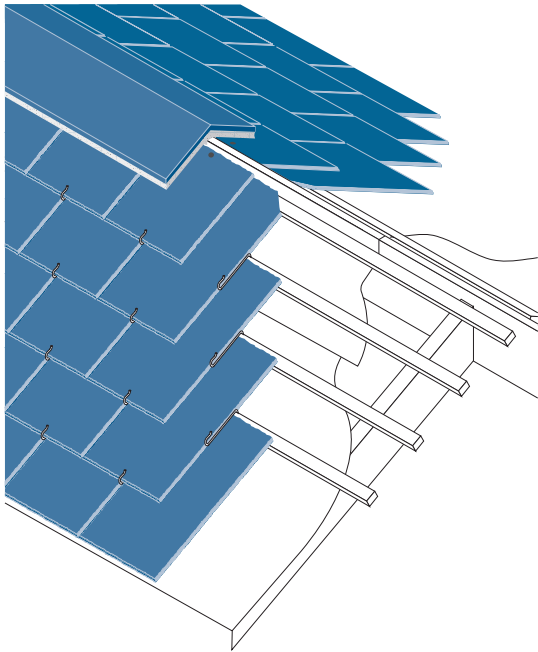

Ridges

The length and gauge of slate in the top courses at the ridge should be sufficient to ensure that the appropriate lap is maintained.

Shouldered slates should be used in the course below the top course to enable the short top course slates to be nailed directly to the batten.

Fixing sequence with tiled ridge

- 1 Fix underlay over the ridge so that it overlaps the main underlay by at least 150 mm. When using the vent ridge, a gap of 50 mm should be allowed between the top of the underlay of each pitch.
- 2 Fix the top course of slates to maintain gauge, using one nail in addition to the hook.
- 3 Lay ridge tiles true. Joint ridge tiles in mortar and firmly bed the edges along the roof slope in mortar. Where ridge tiles meet, squeeze up the bedding to fill the joint and strike it off smoothly; no separate pointing is necessary.

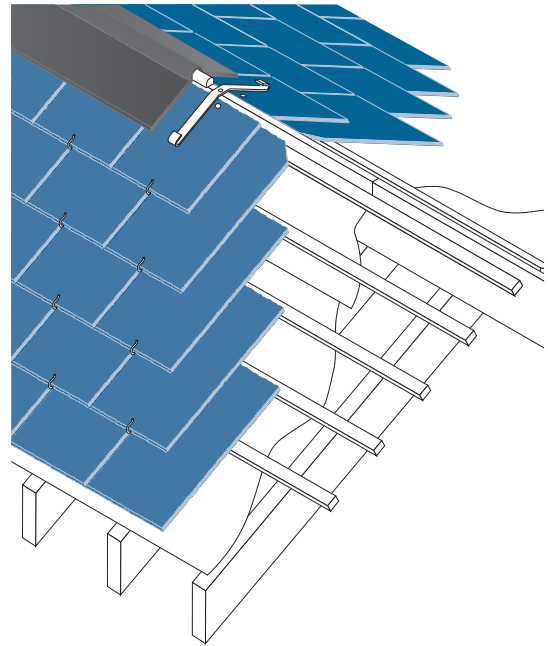

Fixing sequence with sheet metal ridge (not illustrated)

- 1 Fix 250 mm wide board in lieu of battens at the ridge.
- 2 Fix underlay over the ridge so that it overlaps the main underlay by at least 150 mm. When using the vent ridge, a gap of 50 mm should be allowed between the top of the underlay of each pitch.
- 3 Fix the top course of slates to maintain gauge, using one nail in addition to the hook.
- 4 Fix 50 mm zinc tacks at 500 mm intervals.
- 5 Fix nail hooks to the board in a position to secure the eave of the sheet metal ridge. Secure the sheet metal ridges in the hooks, overlapping each ridge piece by 100 mm and nailing it to the board with two clouts on each pitch wherever an overlapping end of the ridge with pre-bonded clips. At verges, hips etc., cut and shape the ridge accordingly.

Note To ensure resistance to wind pull-out, the length of the ridge pieces should not exceed 1 m.

Fixing sequence with lead roll ridge

- 1 Fix underlay over the ridge so that it overlaps the main underlay by at least 150 mm. When using the vent ridge, a gap of 50 mm should be allowed between the top of the underlay of each pitch.
- 2 Fix the top course of slates to maintain gauge, using one nail in addition to the hook.
- 3 Cover the timber roll with Code 6 lead strips 450 to 500 mm wide and 1.5 to 1.8 m long. Lap the strips 75 mm at the joints; secure the lead with screws top sealed with a lead dot under the overlap. Fix 50 mm lead tacks at 750 mm intervals.

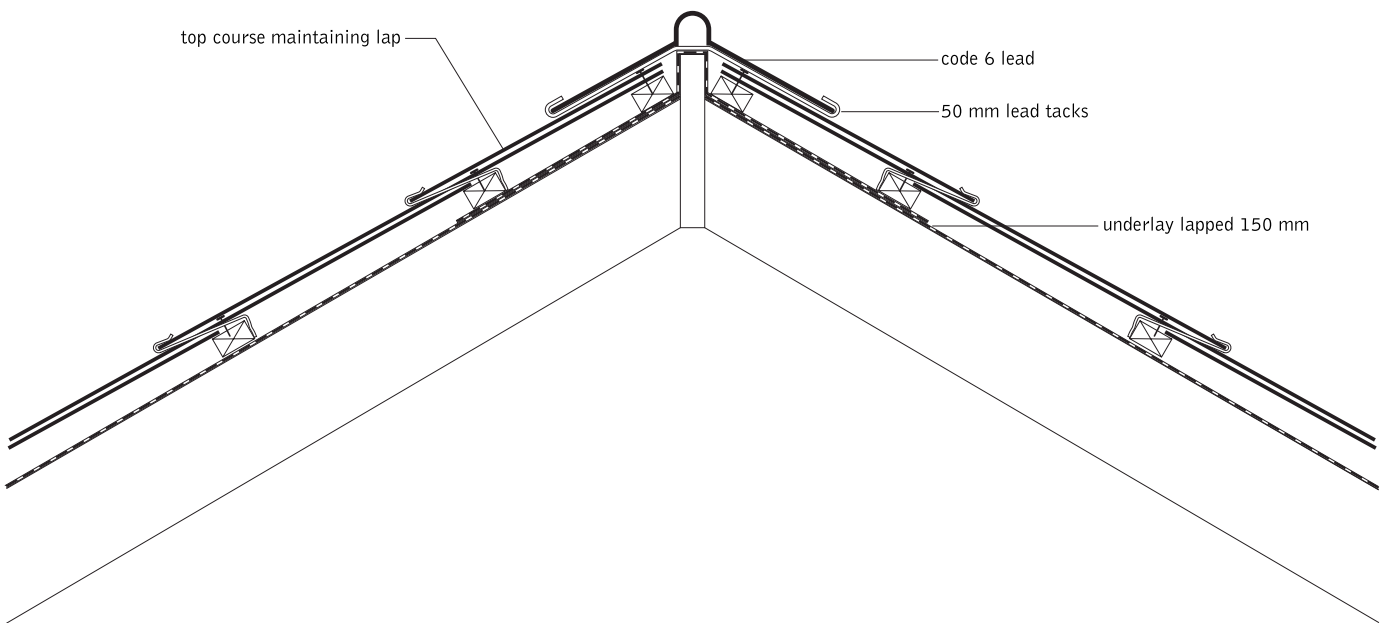
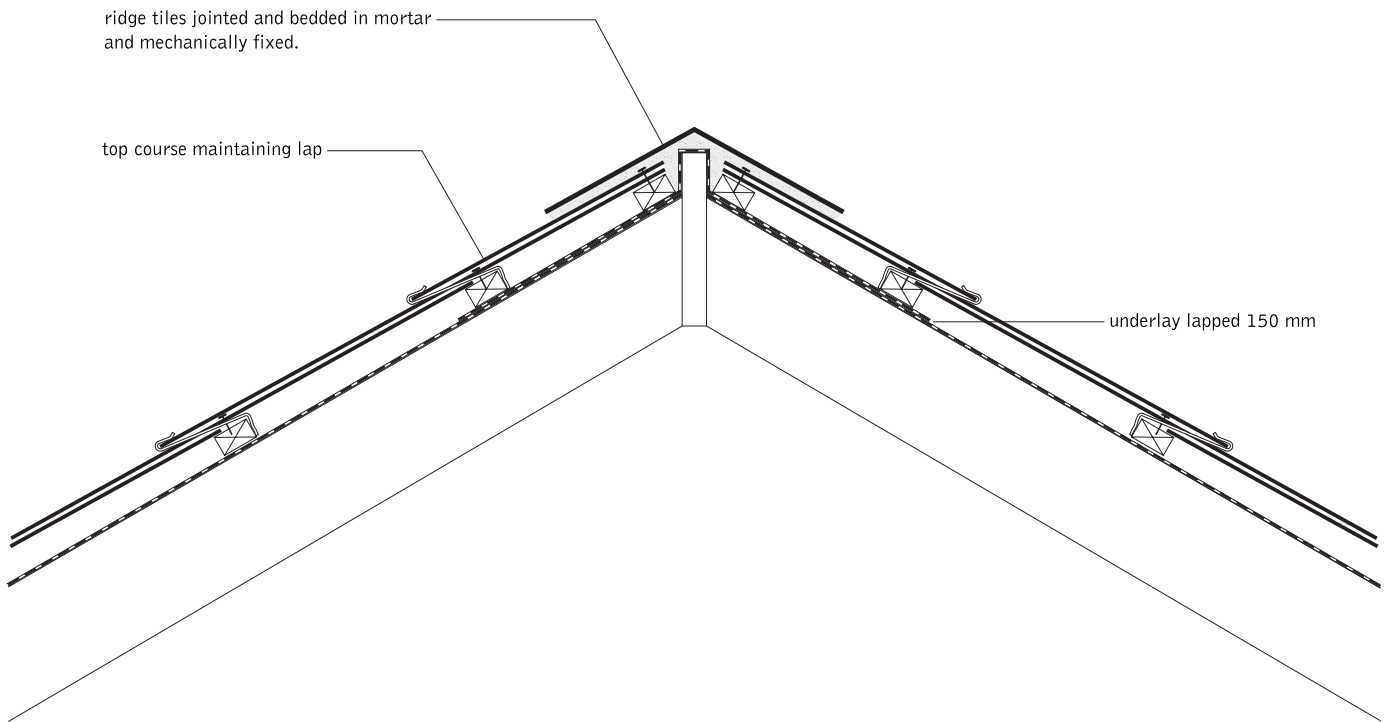

Hips

In cutting slates for hips, care must be taken to preserve an adequate bond, using slate-and-a-half slates.

Where pitches at hips are almost vertical, the hips can be treated in the same way as verges.

Fixing sequence at mitred hip

- 1 Fix 600 mm wide underlay, overlapping the main underlay.
- 2 Cut slates carefully, ensuring that adequate width is maintained at the head. SSQ do not recommend the fixing of mitred hips on roofs where the angle of the hip is 30° or less.
- 3 Hip slates must have an even size and shape at every course. The width of the tail of the hip slate must not be less than the width of a normal slate.
- 4 Using one hook and two nails, fix hip slates interleaved with lead soakers – nailed to battens at the top edge – to provide a weathertight close-mitred joint.
- 5 Cut slates of adequate width to connect with main roof slates and hip slates.

Fixing sequence with lead roll hip

- 1 Fix 600 mm wide underlay, overlapping the main underlay.
- 2 Cover the timber roll with Code 6 lead strips 450 to 500 mm wide and 1.5 to 1.8 m long. Lap the strips 75 mm at the joints equal to the lap of the slates. Fix 50 mm lead tacks at 500 mm intervals, under the timber roll.

Fixing sequence with ridge tiled hip

Mortar 1:3 cement/sand pigmented to approved colour.

- 1 Fix 600 mm wide underlay, overlapping the main underlay.
- 2 Fix hip iron (to BS 5534: Part 1) to hip rafter.
- 3 Cut slates to fit closely at junction.
- 4 Lay hip ridge tiles true and bed edges and joints firmly in mortar, struck off smoothly to provide a flush finish.
- 5 Cut first tile to align with corner of eaves.
- 6 Fill end of hip with mortar and slips of slate finished flush.

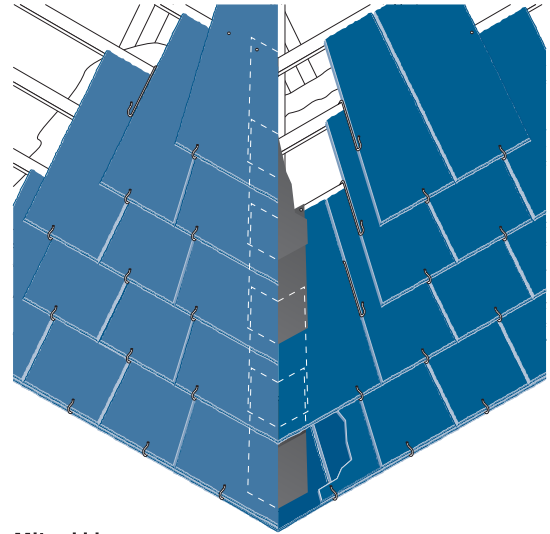

Mitred hip

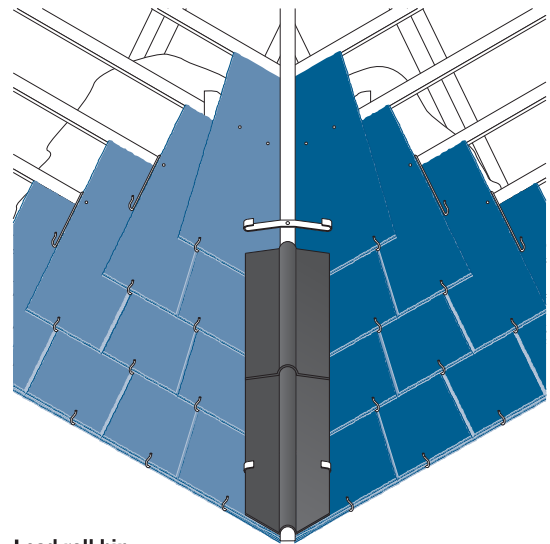

Lead roll hip

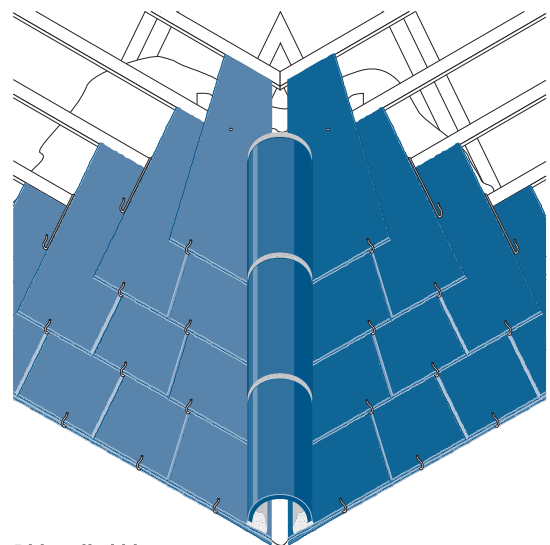

Ridge tiled hip

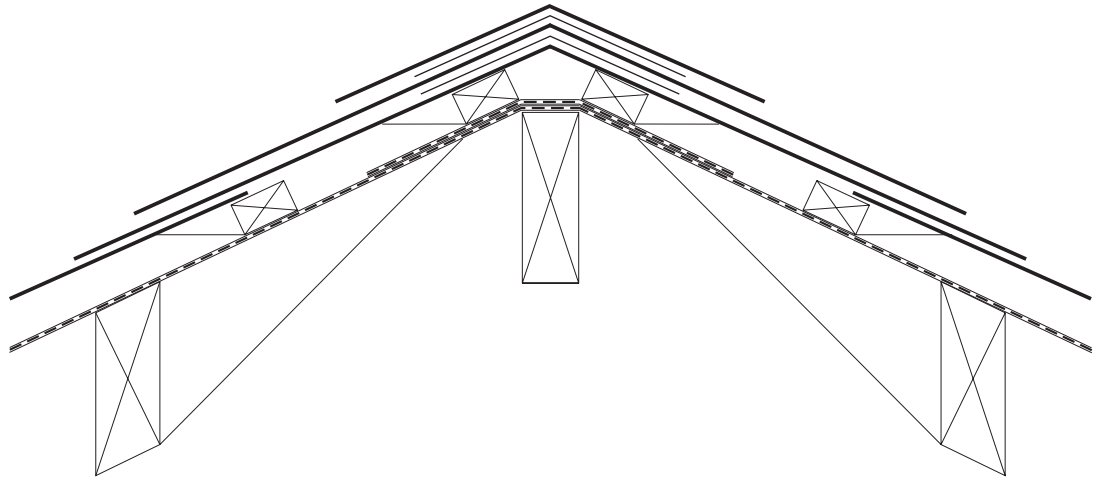

Mitred hip

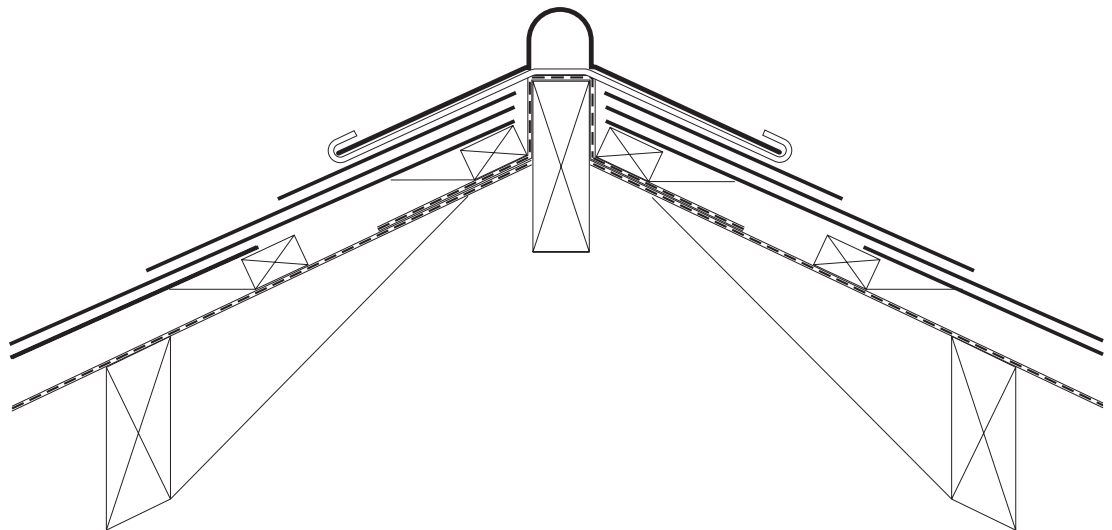

Lead roll hip

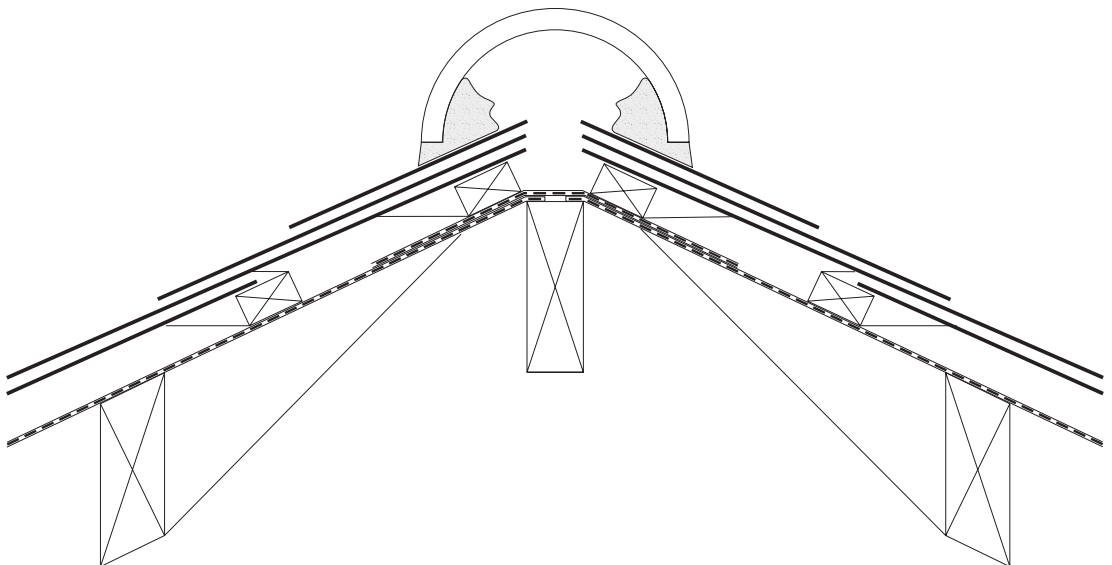

Ridge tiled hip

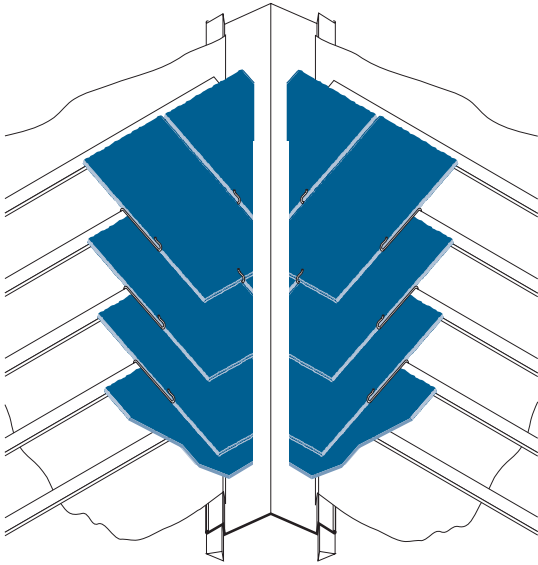

Open valleys

Special care should be taken to ensure that valleys feature a clear unobstructed channel, at least 100 mm wide. Increased kerbing may be required to accommodate mass flow where the pitches on either side of a valley are unequal.

For more information on open lead valleys, please contact the Lead Development Association at:

42-46 Weymouth Street

London W1G 6NP

Telephone 0207 499 8422

or contact the SSQ Technical Department.

Fixing sequence at open valley

- 1 Fix tilting fillets on either side of the valley board and dress underlay over these tilting fillets.
- 2 Lay pre-shaped sheet metal or GRP gutter at least 400 mm wide in the valley, overlapping each piece by 150 mm and securing them with lips at the edges and at the top.
- 3 Cut slates accurately, ensuring sufficient width is retained at the head to put nails in, to overhang the tilting fillet but leave a minimum of 100 mm clear width of valley.
- 4 Secure the edge slates with one nail in addition to the hook, or use two nails if there is no hook.

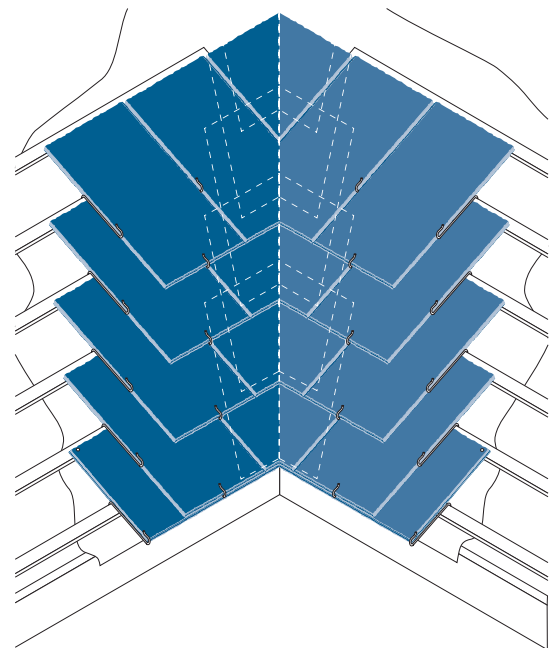

Fixing sequence at mitred valley

- 1 Lay a strip of underlay 600 mm wide over the valley, underlapping the main underlay.
- 2 Cut slate accurately to match with the main roof.
- 3 Fix slates to interleave with Code 3 lead or stainless steel soakers – nailed to battens at the top edge – to provide a straight, weathertight, close-mitred joint. The size of the soaker must be not less than one slate in length; in width, it should be at least half a slate on both sides at the top and at least a quarter of a slate on both sides at the tail.
- 4 Any slates which cannot be secured by a hook in the valley should be left loose.

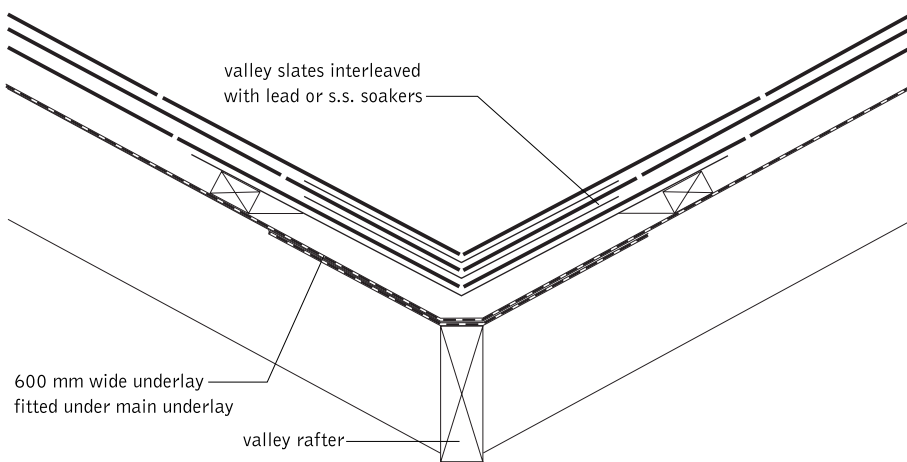
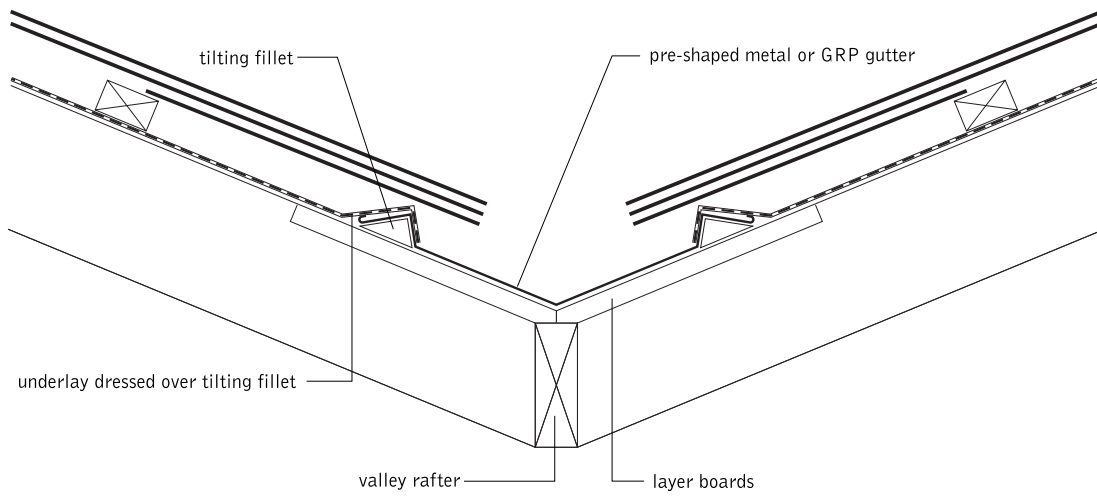

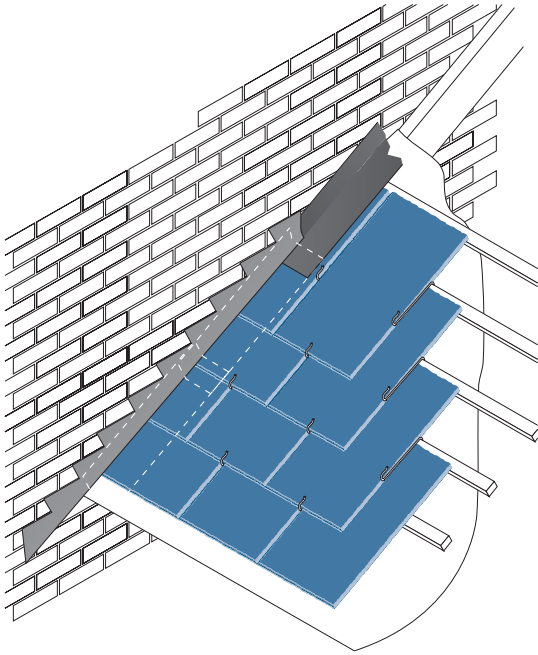

Abutments and parapets

a At end of roofs slope

As nearly as possible, the abutment slates should be slate and slate-and-a-half in alternate courses.

Soakers should be equal to slate length plus 15 mm. The width should be equal to half the standard slate width.

Note To avoid staining when lead is used, a smear coat of patination oil should be applied to the surface of the lead as soon as practical after fixing.

Fixing sequence

- 1 Cut slates as required and interleave with Code 3 lead soakers, dressed to provide at least 75 mm upstand to form a close, weathertight abutment.
- 2 Fix soakers into the battens with nails; soakers should be no shorter than the slate. Fix one soaker under the full slate and none under the half slate.
- 3 Fix code 4 (1.8 kg) lead flashing, or sheet metal flashing pre-shaped to the right width, to be secured in the top course of hooks and turned up against the abutment. Welt top edge, secure into the brickwork joints, to a depth of at least 25 mm, with lead wedges and point in mortar.

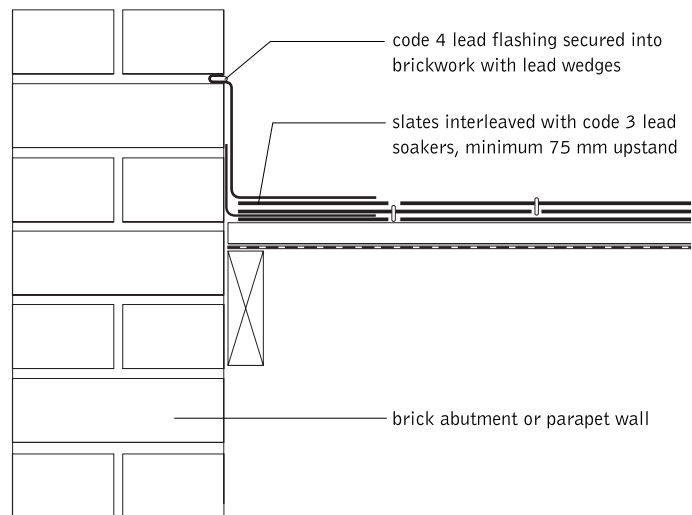

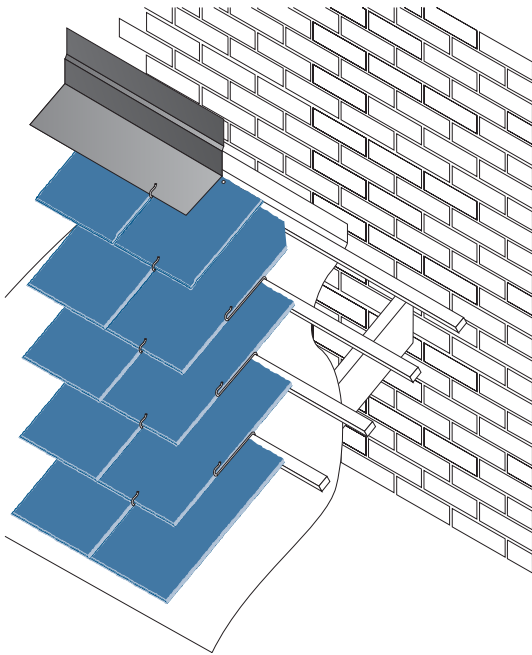

Abutments and parapets

b At top of roof slope

- 1 Turn underlay 100 mm up abutment.
- 2 Fix short slates as the top course to maintain gauge.
- 3 Fix Code 4 lead flashing, or sheet metal flashing pre-shaped to the right width, to be secured in the top course of hooks and turned up against the abutment. Welt top edge, secure into the brickwork joints, to a depth of at least 25 mm with lead wedges and point mortar.

Fixing sequence

- 1 Turn underlay 100 mm up abutments.
- 2 Fix short slates as the top course to maintain gauge.
- 3 Fix Code 4 lead flashing, or sheet metal flashing pre-shaped to the right width, to be secured in the top course of hooks and turned up against the abutment. Welt top edge, secure into the brickwork joints, to a depth of at least 25 mm with lead wedges and point in mortar.

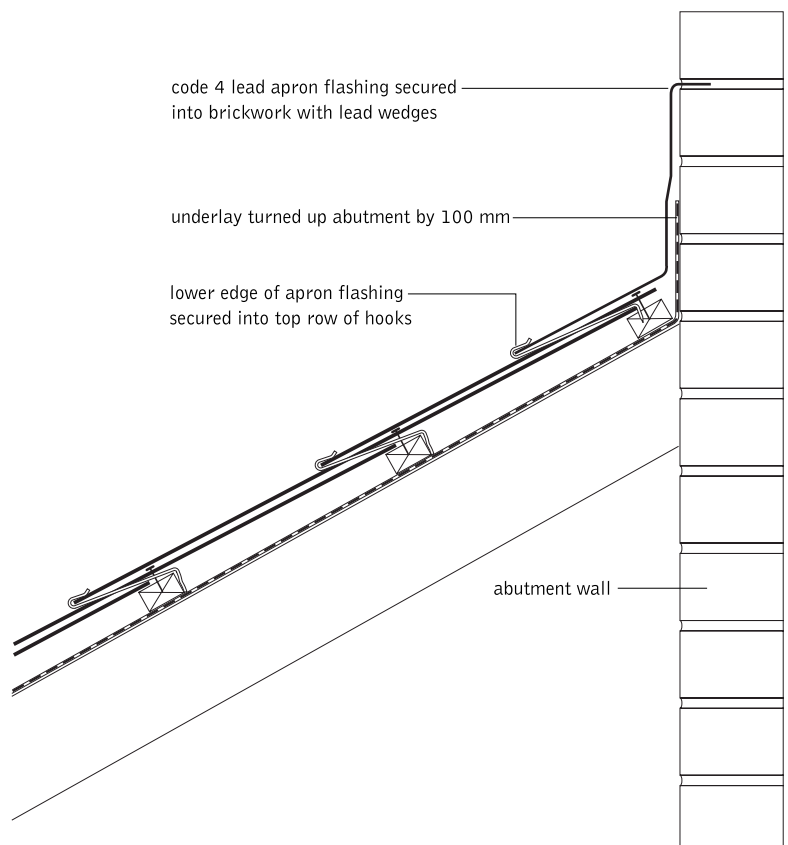

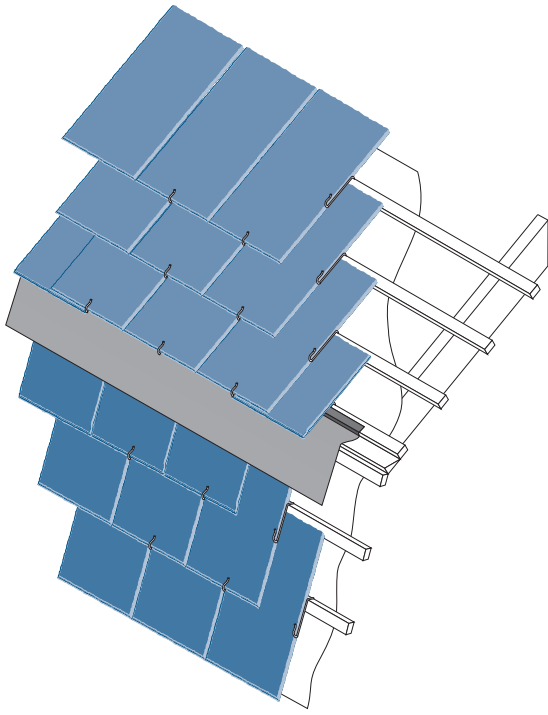

Change of roof pitch/mansard roofs

Fixing sequence at change of roof pitch (mansard roof)

- 1 Slate lower slope as standard for vertical cladding
- 2 Fix tilting fillet to lower edge of upper slope
- 3 Fix Code 5 lead flashing over the undereaves batten and fillet on the upper slope and dress down at least 150 mm over the slates on the lower slope.
- 4 Slate the upper slope as standard eaves with the bottom edge of the upper slates overhanging the flashing by 50 to 60 mm.

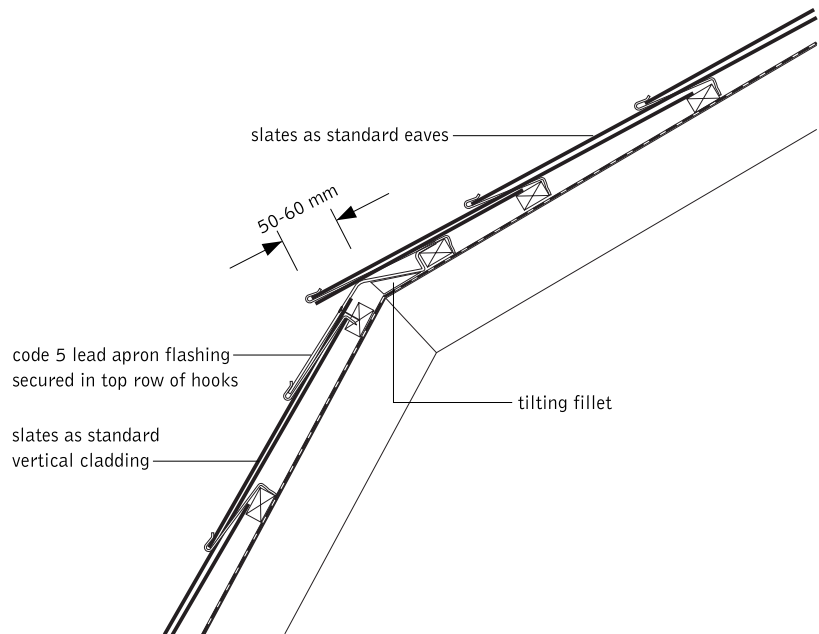

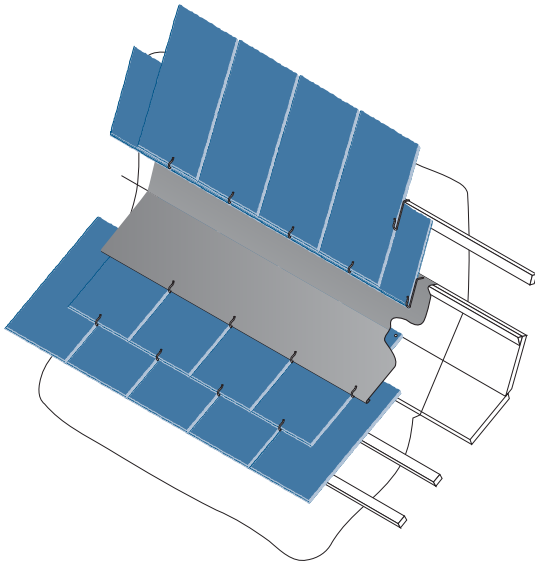

Change of roof pitch

Fixing sequence at reduced change of pitch

- 1 Complete slating lower slope as for standard roof upper edge.
- 2 Fix layer board to the rafters at the bottom of the upper roof slope, equal in thickness to the battens. The top edge of the layer board should correspond in position to the usual undereaves batten.
- 3 Fix tilting fillet to upper edge of layer board
- 3 Fix Code 5 lead apron flashing over the tilting fillet and layer board and dress down over the heads of the slate below by at least 150 mm.
- 4 Slate upper slope as standard eaves, with bottom course projecting below tilting fillet by 50 to 60 mm.

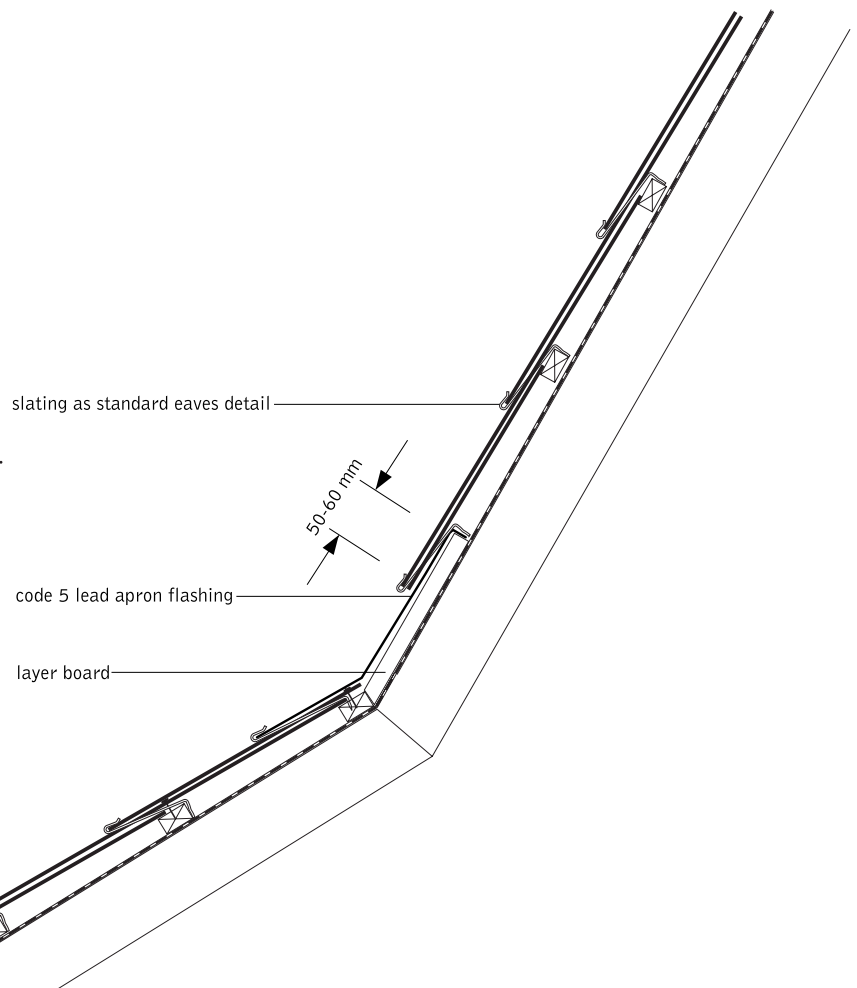

Vertical cladding

SSQ slates used for external wall cladding provide a highly aesthetic appearance as well being extremely functional.

A wide range of cladding patterns can be achieved, which can offer particular benefits of economy and weather resistance as well as allowing versatility in design.

Fixing sequence for vertical cladding

1 Generally

Vertical slating or cladding may be fixed either directly to battens (or to battens and counter battens), firmly fixed to the wall face (see BS5534: Part 1: 2014) The minimum head lap is 32 mm.

2 At lower edge

Fix slates at the lower edge of vertical work in the same way as roof slating.

External corners and abutments to openings should be treated as verges or mitred verges with soakers at every course.

3 At top edge

Finish top course with lead apron fixed on hooks.

4 At abutments

Form abutments with full slates and half slates on alternate courses.

5 At abutments adjacent to openings

Fix full slates and half slates on alternate courses, interleaving with lead soakers. Fix flashings, suitable for the particular window installations, around all openings.

7 At gable ends

Splay cut slates at the ends of courses to fit closely under the verge, either by cutting wide slates to leave a 5 mm gap adjacent to the abutment or cutting the last two slates at the end of every course so that the tail of the end slate is almost at right angles to the verge.

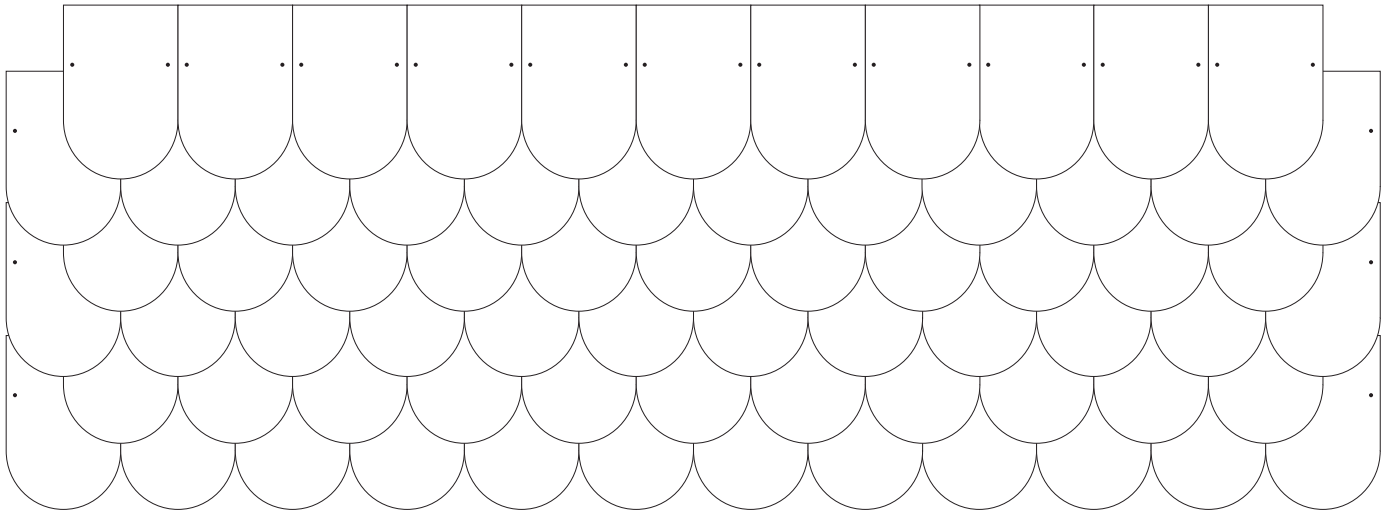

Half round

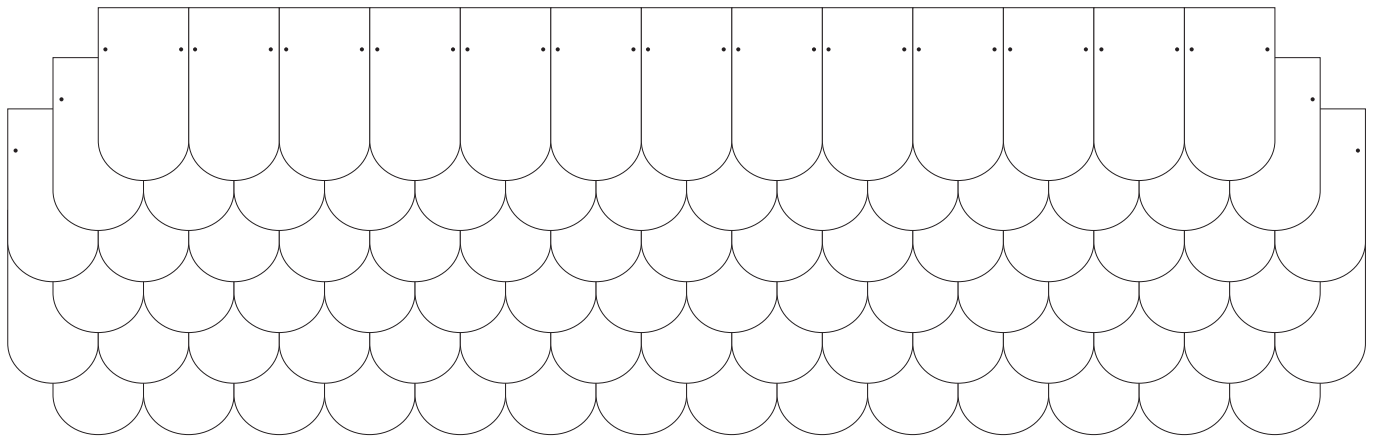

Fish scale

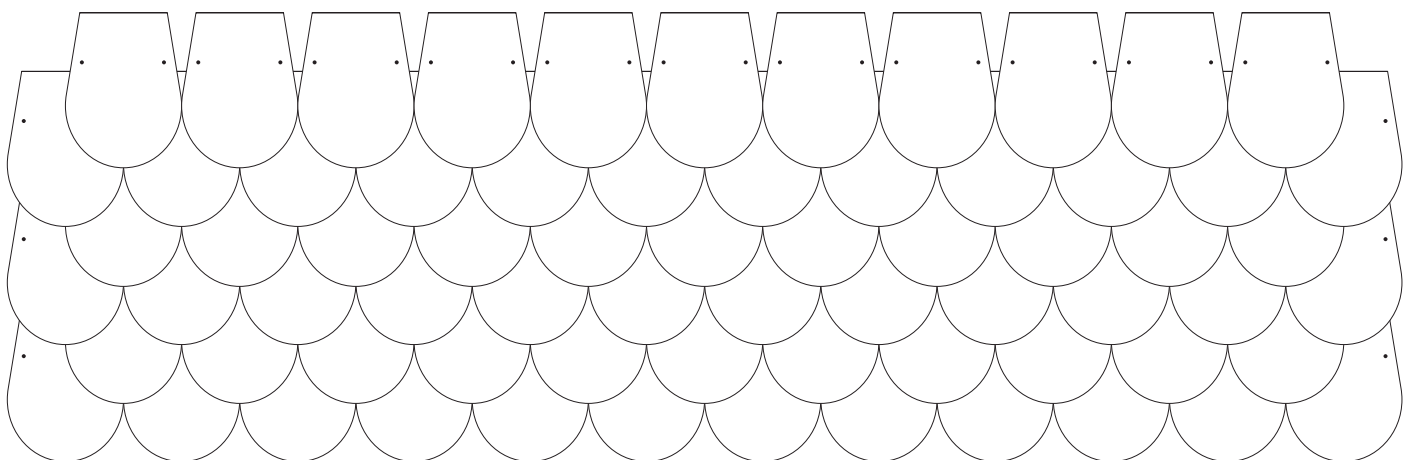

Bullnose

Sitework

Storage on site

Slates should be stored in pallets whenever possible. Slates should be stacked on their long edge on dry, level ground. Two battens should be placed under each row of slates.

Preparatory work

Sorting and stacking slates

Each slate should be inspected and the thicker end selected for the tail. They should be stacked into at least three separate stacks, according to thickness (heavy, medium, thin).

Thick slates should be used on the lower roof (eaves), medium slates on the middle roof and thin slates on the upper roof (ridge) section.

Cutting slates

When using a slate cutting machine for cuts to hips and valleys etc., proper adjustment and maintenance is required.

To maintain adequate laps and allow proper fixing, slates must not be cut too narrow. As a general rule no slate should be less than half a slate wide.

At hips and other angled surfaces, the slates must be cut on the rake using wider slates to maintain an adequate width of head of not less than 50 mm.

Hook fixing method

Full details of the labour saving hook fixing method are available on request from SSQ Technical Department.

Hook shaped stainless steel fixings are used instead of nails to support the slates, eliminating the need to hole individual slates.

Where slates are laid on battens, nail hooks must be used. Slates laid on fully boarded roofs are secured by nail hooks.

The length of hook should be at least 10 mm longer than the minimum head lap required. Hooks are available from 60–160 mm lengths in 10 mm increments.

- 1 Fix underlay as specified.
- 2 Mark out the roof to the correct batten gauge.
- 3 Fix battens.
- 4 Check width of slates, add 3 mm for the hook and mark out the slate joints and slate centres (perpends). It is generally necessary to mark out only two lines for every three slates on battens and every perpend when fixing to full boarded roofs.
- 5 Fix batten or nail hooks as appropriate on perpend lines and secure slates. Perimeter slates should be fixed with additional nail(s).

Hook fixing Installation

With this system, straight lines must be maintained in the courses of slates and it is necessary to mark out these lines prior to fixing.



MARKING OUT (see Fig 1.)

1. Using a chalk string, mark the centre line of each batten, checking also that the battens are positioned at the chosen gauge.

Vertical battens must be fixed at the verges to accept nail fixing.

The felt underlay is to be draped over batten (i) at the eaves (see FIXING below)

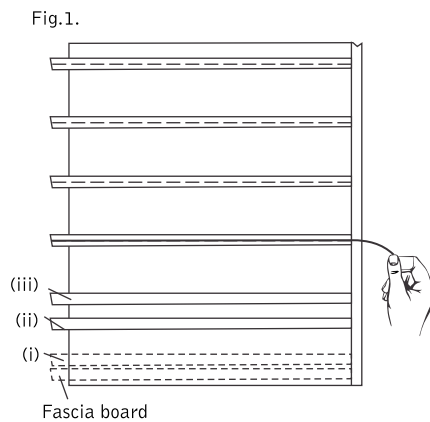

2. Mark out the position of each slate joint along the battens as follows:

a) Working from one verge, first mark out a full slate width on both the eaves and apex battens. Then, continue marking along these battens at intervals of a full slate width plus 5 mm to allow for the hook fixing.

b) Using the chalk string from eaves to ridge, copy the positions of these markings onto all the other battens.

c) Starting again from the original verge, mark a half width slate onto the eaves and apex battens. Then, continue as before, marking along those battens at a full slate width plus 5 mm for the hook fixing.

d) Using the chalk string as before from eaves to ridge, copy the positions of all these markings onto all the other battens up the roof slope.

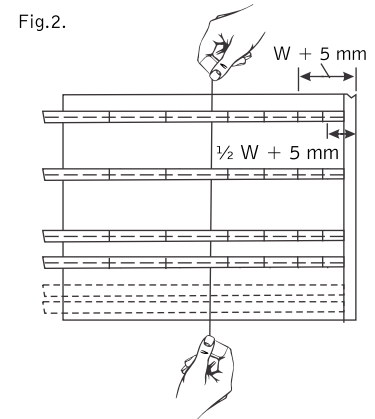

FIXING

3. With hook fixing, only one under-course of slates is used at the eaves, with the felt being draped over batten (i) see fig 1.

Consequently, the nail hooks in batten (i) must be fixed before the felt is laid over them (See figure 3). Fix a line of hooks into batten (i), lining them up with the previously made position marks. Lay the felt carefully into the hooks.

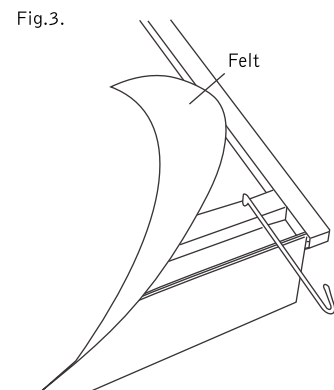

4. Drill the under-eaves slates and fix a complete course by nailing them into batten (ii) in such a way that the hooks previously fixed into batten (i) fall into the gaps between the slates. (See Figure 4)

Fig.4

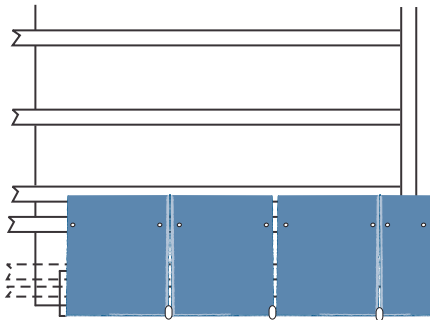

5. Using the position markings, fix a second line of hooks into batten (iii), positioning them at the centre line of each under-eaves slate.

(See Figure 5). Fix a complete course of eaves slates by sliding them centrally by the tail into those hooks fixed previously into batten (i) For security, also nail the eaves slates into batten (iii)

Fig.5

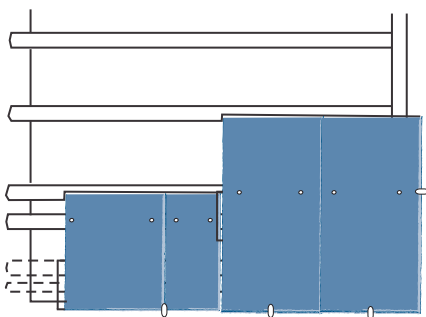

6. Continue slating up and across the roof, laying a triangular area from the verge/eaves corner.

For extra security, each full and half width verge slate is drilled and fixed with three nails. If desired, even further security can be obtained by locating the verge slate edges into hooks fixed horizontally along the battens at right angles to their normal position.

All other slates are secured at the tail, by the hook only, and are not nailed into position. (See Figure 6.)

Continue inserting nail hooks and laying slates in position up and across the roof.

The final slates at the apex and the opposite verge are nailed into position in the normal manner.

Fig.6

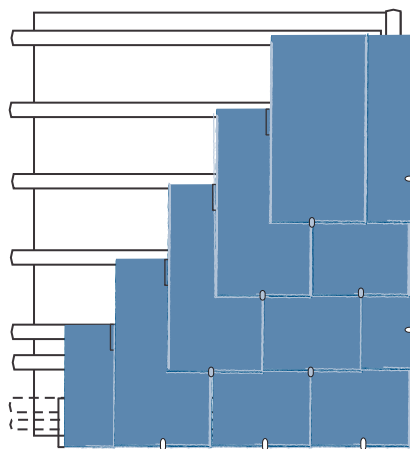

ALTERNATIVE EAVES/VERGE FIXING

Nails are used to secure eaves and verge slates, the hook fixings being employed elsewhere.

This enables a double eaves course and slate-and-a-half widths at verges to be fixed.

HIPS & VALLEYS

Where these details occur, it is essential to secure the skew cut slates with nails and hooks.



Spanish Slate Quarries UK Limited
301 Elveden Road
Park Royal
London NW10 7SS
United Kingdom

tel +44 (020)8 961 7725

fax +44 (020)8 965 7013

www.ssqgroup.com

email info@ssq.co.uk



EXCLUSIVELY **NATURAL SLATE**